

SCHWINN

A World of Daily Innovation



Garderoben & Ordnung

Wardrobes & Organization

Armoires & Ordre / Guardaroba & Ordine

Armari & Orden / Garderoby i organizacja

Haken, Reling und Konsole – mehr als man glaubt

Um sich seiner alltäglichen Dinge im Eingangsbereich zu entledigen bedarf es raffinierter Lösungen. Hiervon bietet Schwinn eine breite Palette an Innovationen rund um die Garderobe.

Diese Katalog-Broschüre ist eine aktualisierte Rubrik aus unserem Beschläge-Sortiment mit mehr als 3000 Artikeln. Griffe & Knöpfe – Profile – Möbelfüße & Rollen – funktionale & dekorative Elemente. Dies alles finden Sie bei Schwinn. www.schwinn-group.com

Hooks, railing, and shelf supports – a place for everything

There are so many things that need a place. In the hall, bathroom, kitchen, laundry, study, bedroom, garage or office. They all require smart solutions. Schwinn offers a broad range of innovative products to put everything in the right place.

This brochure shows a selection from our more than 3000 designs. Other categories include Handles & Knobs – Profiles – Casters & Furniture Feet – Functional & Decorative Elements. Schwinn has it all.

Visit our web site at www.schwinn-group.com to see the entire program.

Accessoires de rangement : bien plus que ce que l'on croit

Pour faire face aux nombreuses demandes de rangement dans la maison, Schwinn propose une gamme très large d'innovations raffinées autour du vestiaire.

Ce catalogue actualisé est issu de notre gamme complète de plus de 3000 articles.

Poignées et boutons – Profilés – Pieds et roulettes – Pièces fonctionnelles et éléments décoratifs.

Ce sont les produits de la gamme Schwinn. Visitez notre page internet: www.schwinn-group.com

Ganci, sottopensili, divisori per cassetti e quant'altro

Schwinn offre una vasta gamma di prodotti per i guardaroba. Le soluzioni più sofisticate per ciò che riguarda gli ingressi. Questa brochure è una rubrica aggiornata con più di 3000 nostri articoli. Maniglie e pomoli – Profilo – Piedini e ruote – Elementi decorativi e funzionali. Tutto questo lo trovate alla Schwinn.

Visitate il nostro sito: www.schwinn-group.com

Perchas, ganchos y soportes: Cada cosa en su lugar

El poder ordenar los accesorios cotidianos en la zona de entrada requiere soluciones elegantes. Schwinn ofrece una amplia gama de opciones para los armarios.

Este folleto muestra una selección de nuestros más de 3000 artículos. Schwinn les puede ofrecer pomos, perfiles, tiradores, ruedas, patas e incluso accesorios a la carta.

Visite nuestro sitio web en www.schwinn-group.com para conocer toda nuestra gama.

Nóżki i rolki do mebli - kwestia ustawienia

Jest tak wiele codziennych spraw, które potrzebują swojego miejsca. W przedpokoju, w łazience, kuchni, gabinecie, sypialni, garażu lub biurze. Wszystkie wymagają inteligentnych rozwiązań. Schwinn oferuje szeroki wachlarz innowacyjnych produktów, które pozwolą umieścić wszystko we właściwym miejscu.

Ten folder jest zaktualizowaną listą naszego asortymentu okuc z ponad 3000 artykułów.

Uchwyty i gałki – Profile – Stopki i rolki do mebli – Elementy funkcjonalne i dekoracyjne.

To wszystko znajdziecie Państwo w firmie SCHWINN. Zapraszamy również na naszą stronę firmową:

www.schwinn-group.com







































































Symbole Icons / Symboles / Simboli / Simbolos / Symbole













































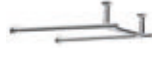















	Bohrlochabstand Center to Center / Entraxe / Interasse / Distancia entre ejes / Odległość pomiędzy otworami
	Länge Length / Longueur / Lunghezza / Longitud / Długość
	Breite Width / Largeur / Larghezza / Ancho / Szerokość
	Höhe Height / Hauteur / Altezza / Altura / Wysokość
	Durchmesser Diameter / Diamètre / Diametro / Diámetro / Średnica

Materialien Materials / Materiau / Materiali / Material / Materiały

	Kunststoff Plastic / Plastique / ABS / Plástico / Tworzywo sztuczne
	Aluminium Aluminium / Aluminium / Alluminio / Alumínio / Z pozdrowieniami
	Metall Metal / Métal / Metallo / Metal
	Edelstahl Stainless Steel / Acier inoxydable / Acciaio / Acero Inoxidable / Stał szlachetna
	Holz Wood / Bois / Legno / Madera / Drewno
	Gummi Rubber / Caoutchouc / Gomma / Goma / Kauczuk

Übersicht / Overall view / Enquête / Indice / Przegląd

					
6 6K104	8 6K155	11 66062	13 33178	16 22236	21 66025
					
6 6K289	8 22971	11 66427	14 22198	17 22234	21 66024
					
6 22184	9 22069	11 66395 / 22174	14 22048	17 22327	22 33171
					
6 6K397	9 22084	11 66396	14 22434	17 6K110	22 33173
					
7 22980	9 22131	11 33154	15 22046	17 6K164	22 33174
					
7 22333	9 22467	12 33906	15 22689	18 66865	22 33175
					
7 6K326	9 22177	12 33907	15 22317	18 66671	22 33176
					
7 6K304	10 22270 / 66482	12 33905	15 22360	19 66886	23 34012
					
7 22044	10 66524	13 33901	15 22354	20 33707	23 34013
					
8 22187	10 22301	13 33902	16 22093	20 6K184	24 66284
					
8 66807	10 66717	13 33903	16 22337	21 22314	24 66285
					
8 6K090	10 22304	13 33177	16 22313	21 22118	24 66265

 25 22300	 27 66649	 31 22038	 34 22267	 37 22947	 41 6K361
 25 66540	 28 22071 / 66261	 31 22215	 34 22267	 38 6K341	
 25 66472	 28 66261+6K156	 31 33796	 34 33633	 38 6K214	
 25 66525	 28 66648	 31 33797	 35 44649	 38 22943	
 26 22345	 29 22749	 32 66579	 35 44643	 39 33940	
 26 22316	 29 22750	 32 66081	 36 22034	 39 22247	
 26 22348	 29 22703	 32 66438	 36 22039+22040	 40 66796+66797	
 26 66580	 29 22740	 32 22070	 36 22039+22041	 40 22195	
 26 22978	 30 22681	 33 22969	 36 22316	 40 22194	
 27 22276	 30 22784	 33 22967 / 6K276	 37 22800	 41 6K094+66797	
 27 22083 / 66263	 30 22571	 33 22104	 37 22918	 41 6K094	
 27 66263+6K156	 30 22505	 33 44616	 37 22573	 41 22335	

6K104

64	56	3/16	130

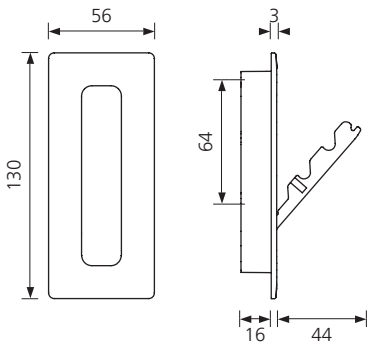

6K289

64	37	3/16	131

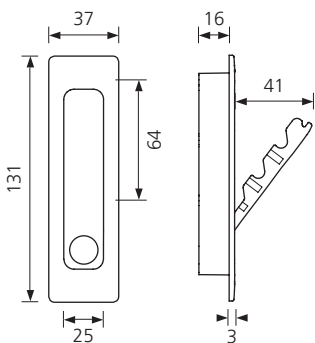

6K397

16/64	18	16	80
96/160	18	16	176

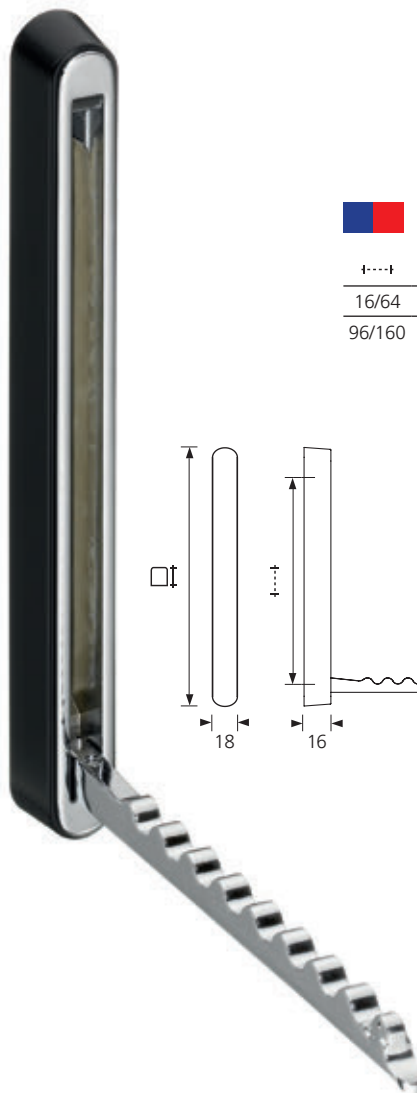
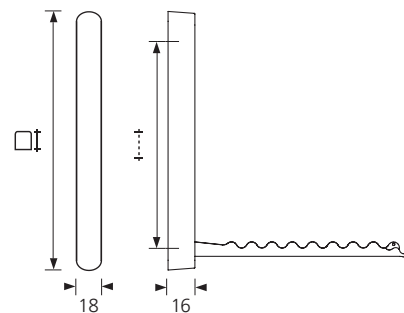

2Z184

64	13	32	75
160	13	128	171

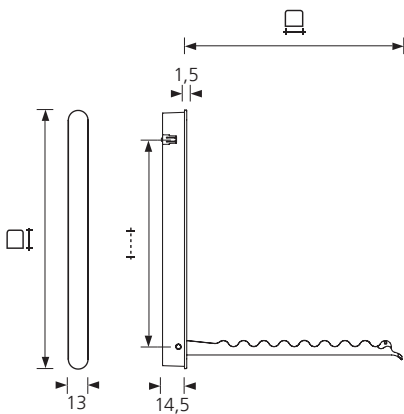

22980

64	76	14/30	76

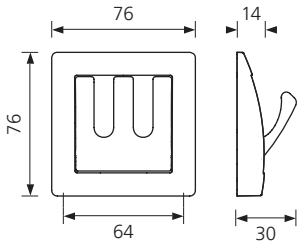

2Z333

32	58	14/27	58

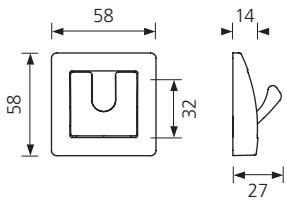

6K326

96	115	6,5/19	44

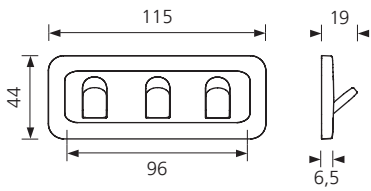

6K304

32	27	20/55	75

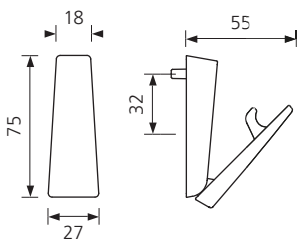

2Z044

19	15/39	65

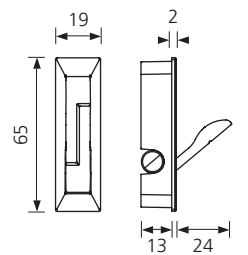

22187

+	+	+	+
16	11	32	50

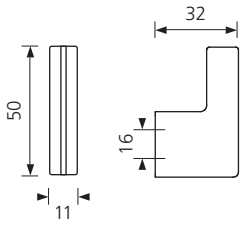

66807

+	+	+	+
16	14	29	42

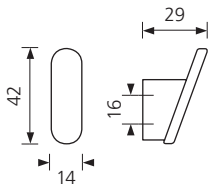

6K090

+	+	+	+
12	10	21	42

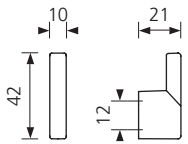

6K155

+	+	+	+
16	10	21	48

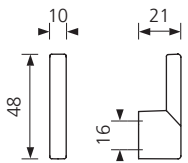

22971

+	+	+	+
12	9	23	45
16	9	23	45

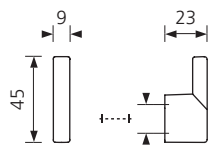

2Z069

16	25	30	20
16	26	45	29

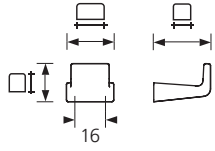

2Z084

16	26	36	28

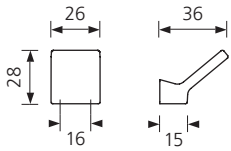

22131

12	20	24	26

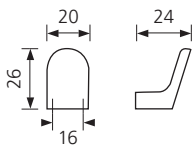

22467

16	22	29

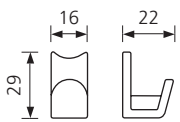

22177

24	30	30

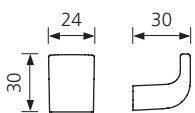

66482

22270

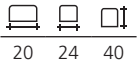

20 24 40

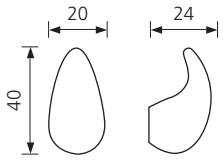

66524

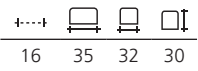

16 35 32 30

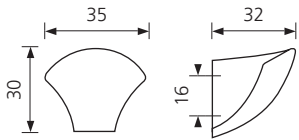

22301

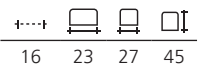

16 23 27 45

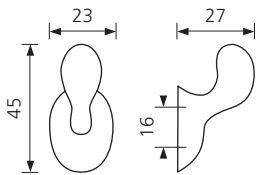

66717

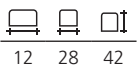

12 28 42

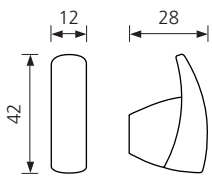

22304

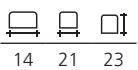

14 21 23

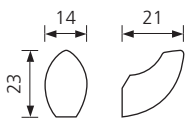

66062

∅
35 15

35
34



66427

∅
65 34

65
34



66395

22174

∅
26 12

26
12



66396

∅
82 19

82
19



33154

∅
30 10
60 10

10



33906

□	∅
30	20
35	20
45	20

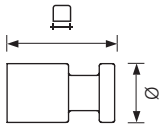

33907

□	∅
40	40
45	45
50	50

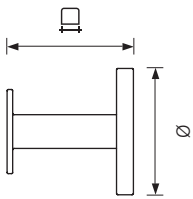

33905

+	□	□	□
64	25	80	104

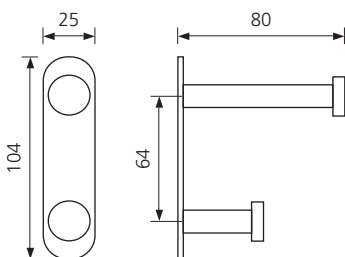

33901

□	□	∅
25	28	25
35	28	25
50	28	25

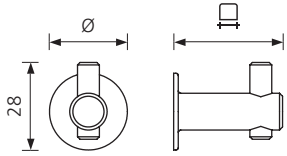

33902

□	□	∅
70	50	30

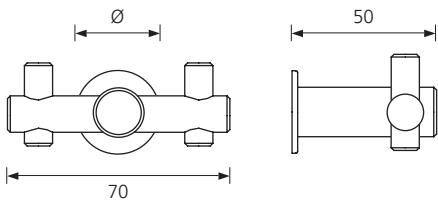

33903

□	□	∅
35	50	30
35	80	30

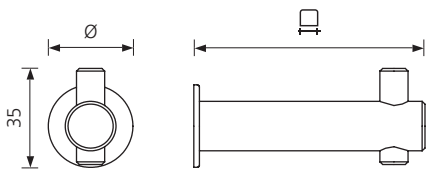

33177

+	□	□	□
20	20	42	71

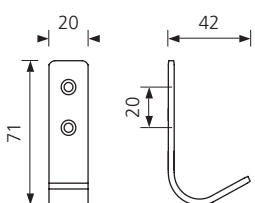

33178

+	□	□	□
20	20	68	172

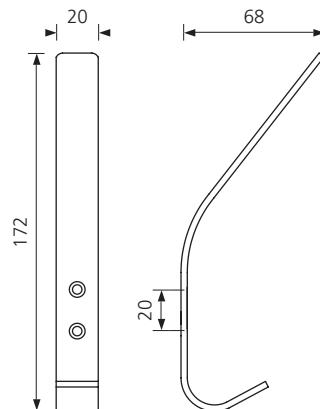

22198

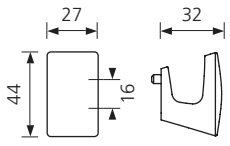
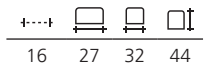

22048

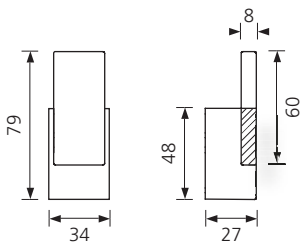

22434

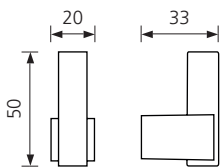

22046

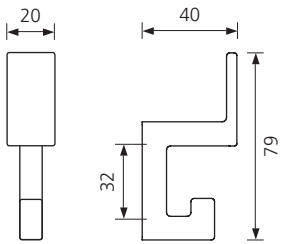
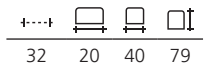

33



22689

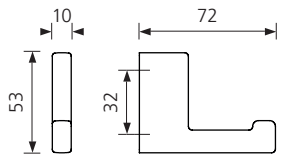
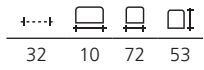

22360

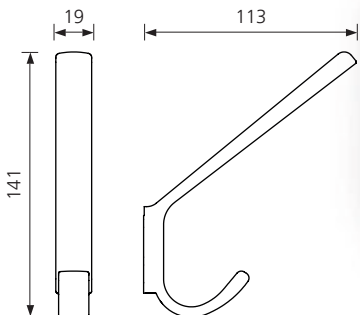

22317

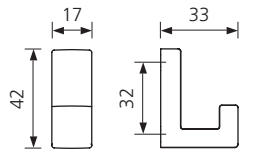
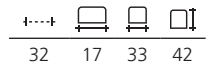

36

22354

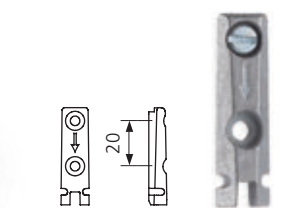
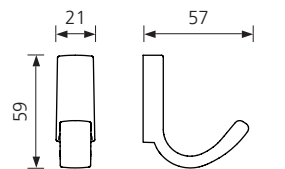

20

22093

20	65	47	73

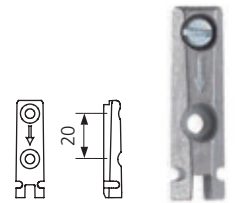
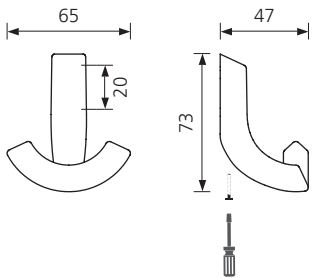

22337

32	80	35	71

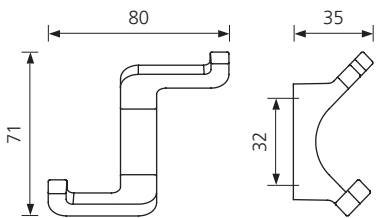

22313

50	41	50

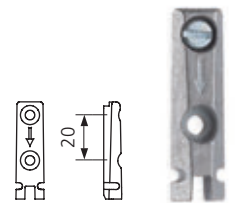
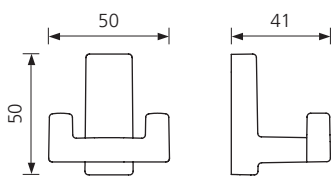

22236

16	36	37	95

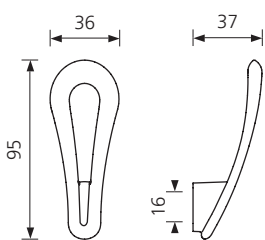

2Z234

16	74	53	103

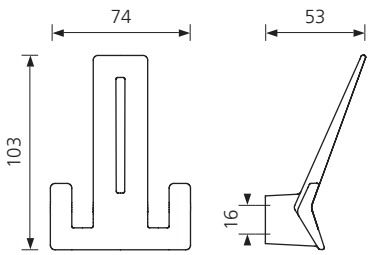

2Z327

20	57	27	65

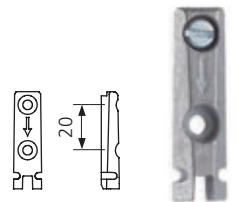
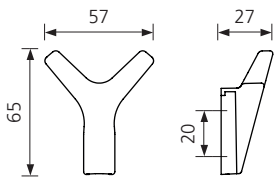

6K110

32	82	48	86

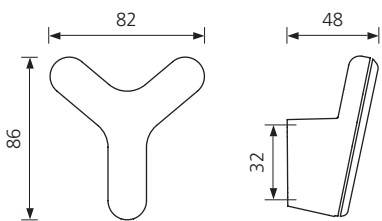

6K164

32	84	48	81

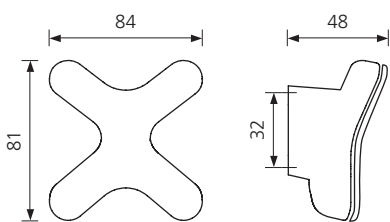

66865

2x100	240	46	107	
4x100	440	46	107	

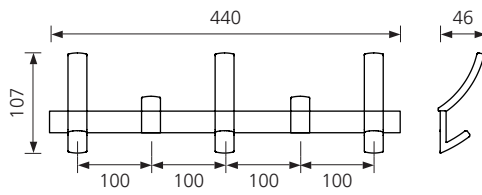
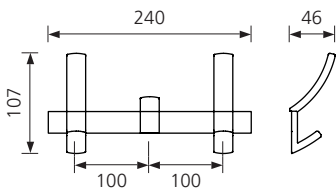

66671

2x100	240	27	46	
4x100	440	27	46	

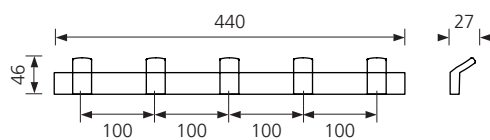
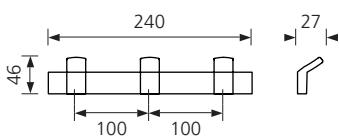

66886

+	+	+	+
2x100	240	20	68
4x100	440	20	68

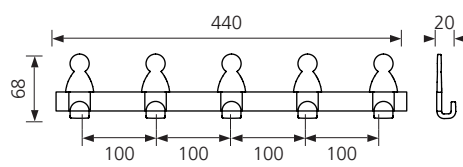
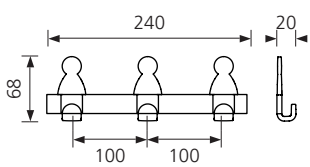

33707

+	+	+	+
640	680	12/27	40/55

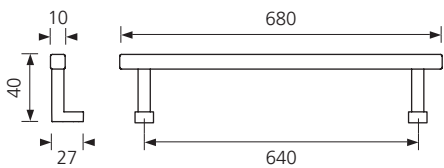

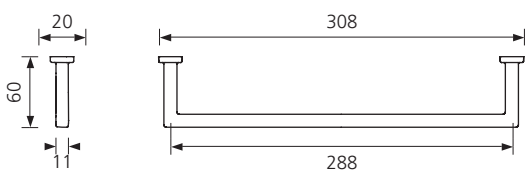

6K184

+	+	+	+
288	308	20/11	60



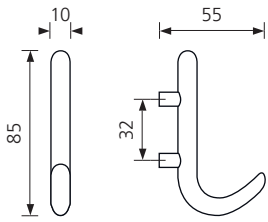

22314

			
32	10	55	85



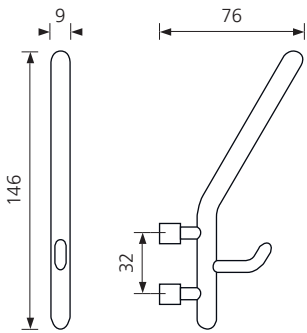

22118

			
32	9	76	146



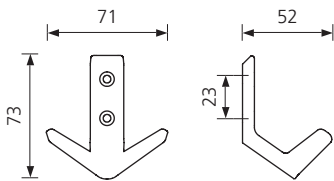

66025

			
23	71	52	73



66024

			
23	71	97	166

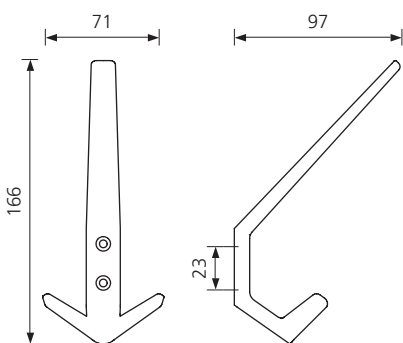

33171

+...+				Ø
17	45	70	100	8
17	45	70	220	8

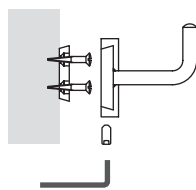
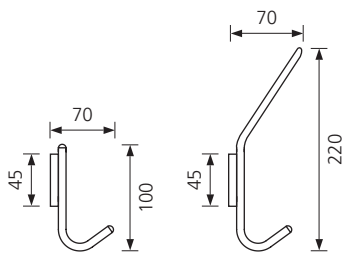

33173

+...+				Ø
76	95	68	155	8

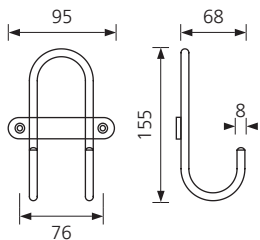

33174

+...+				Ø
76	95	68	217	8

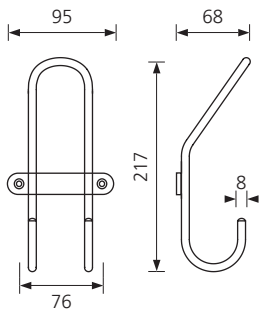

33175

+...+				Ø
32	48/76	40	100	7

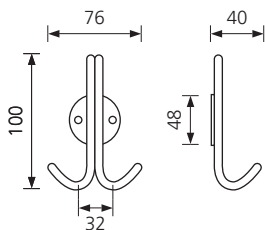

33176

+...+				Ø
32	48/76	55	187	7

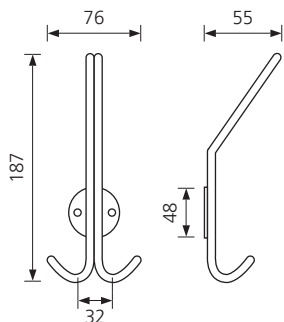



34012

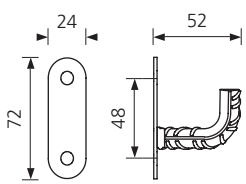
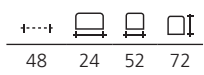

34013

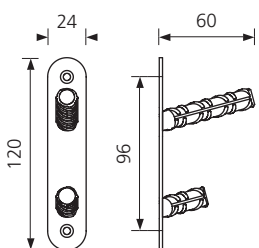
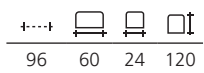

66284

+	+	+	+
23	23	41	71

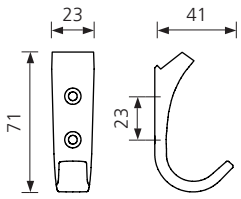

66285

+	+	+	+
23	23	98	160

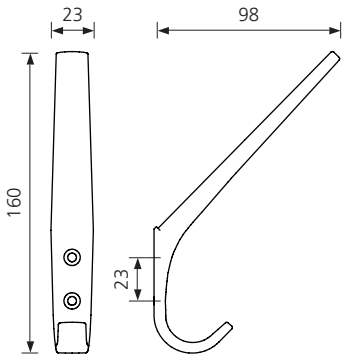

66265

+	+	+	+
32	83	100	178

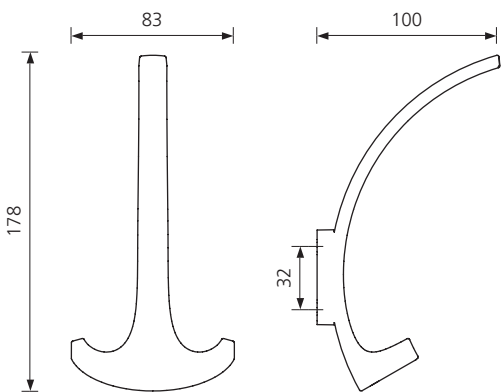

22300

32	9	61	134

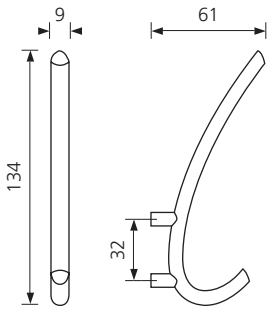

66540

32	65	68	125

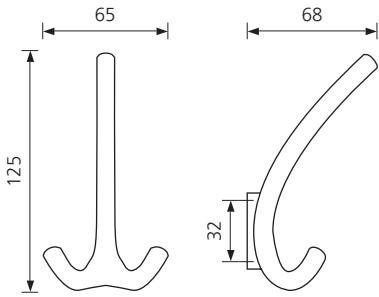

66472

32	17	70	118

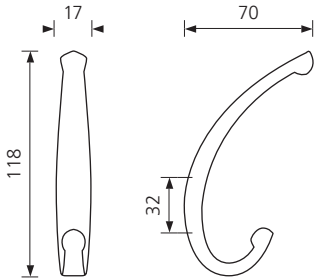

66525

16	30	40	115

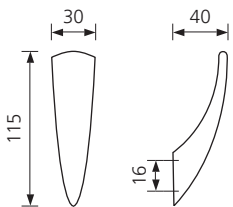

22345

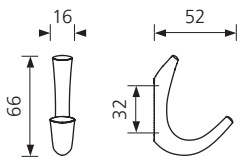
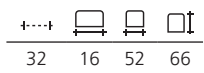

22316

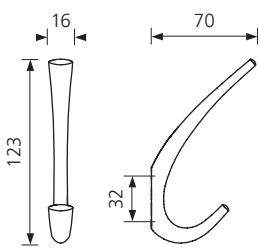
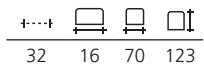

22348

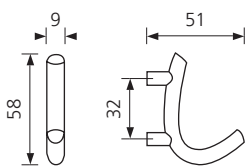
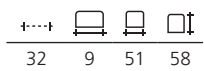

66580

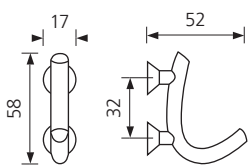
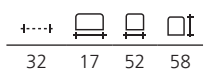

22978

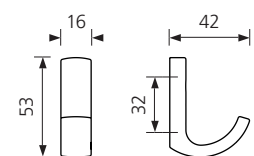
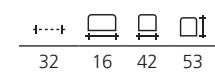

22276

+	+	+	+
32	34	38	80

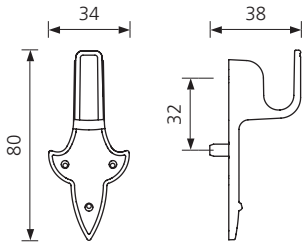

66263

+	+	+	+
32	12	69	68

22083

+	+	+	+
32	12	69	68

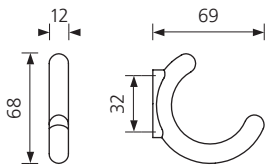

66263+6K156

+	+	+	+
32	45	67	69

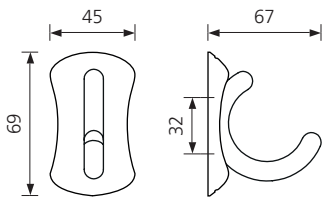

66649

+	+	+	+
32	38	71	70

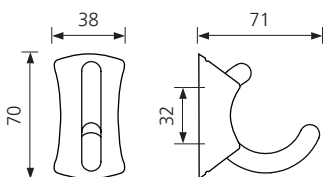

66261

22071

+	+	+	+
32	24	88	138

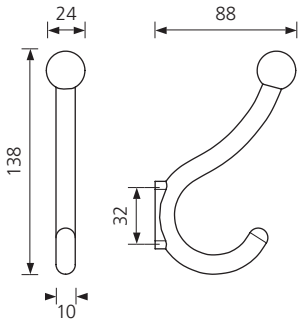

66261 + 6K156

+	+	+	+
32	45	88	138

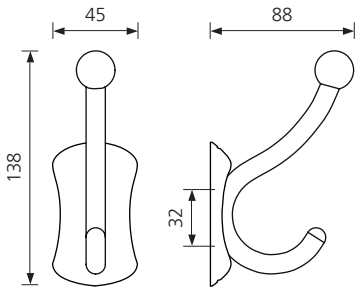

66648

+	+	+	+
32	38	88	139

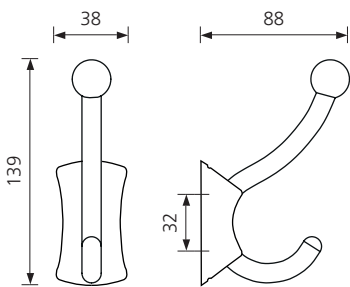

22749

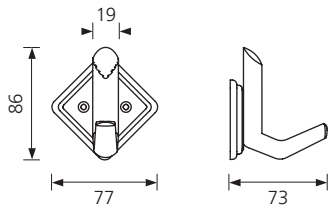
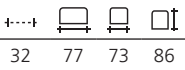

22750

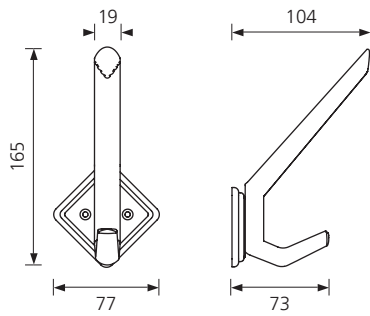
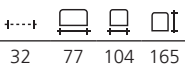

22703

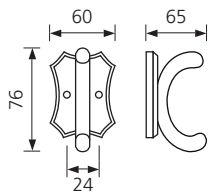
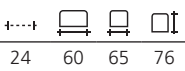

22740

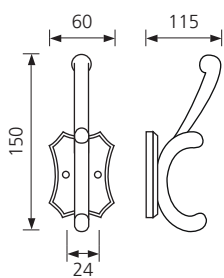

22681

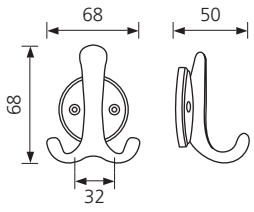

22784

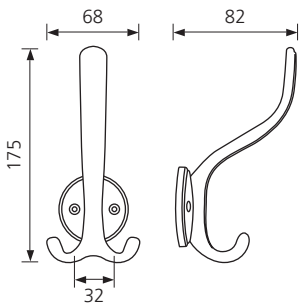

22571

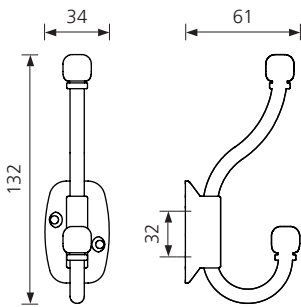
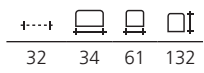

22505

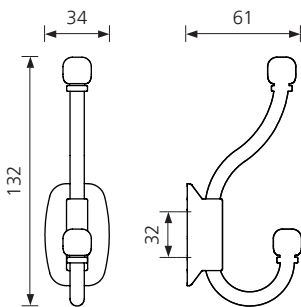
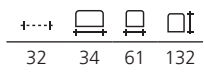

22038

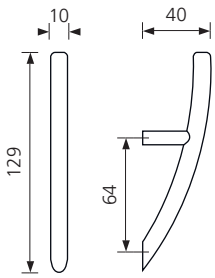

22215

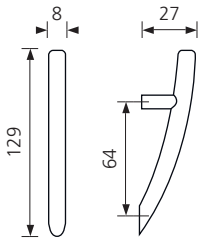
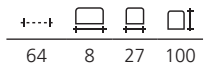

33796

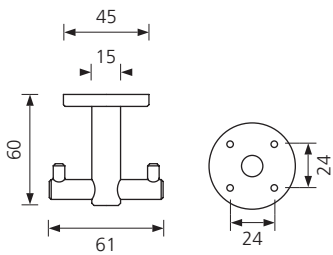

33797

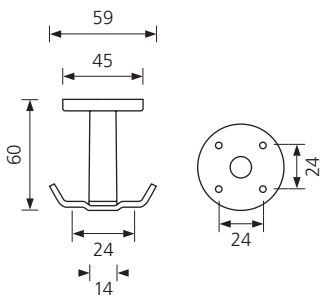
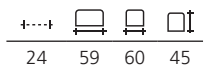

66579

+	+	+	+
224	244	20	63

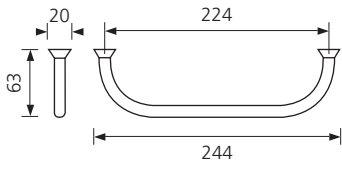

66081

+	+	+	+
80/80	185	24	44

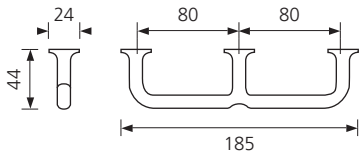

66438

+	+	+	+
96	172	10	49

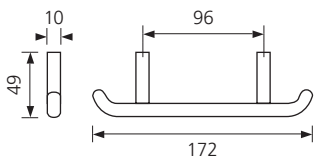

22070

+	+	+	+
192	250	12	63

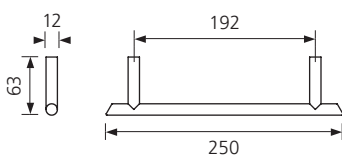

22969

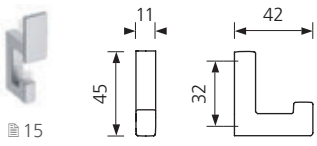
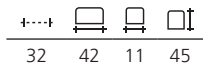

6K276

22967

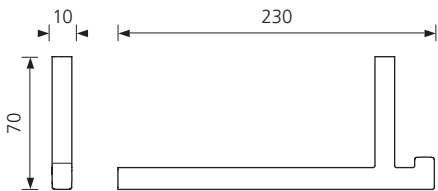
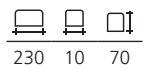

2Z104

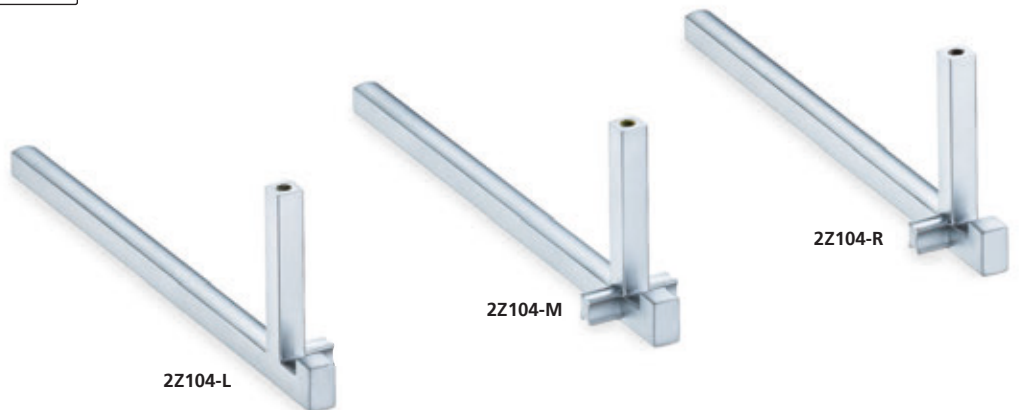
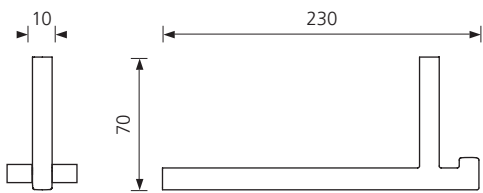
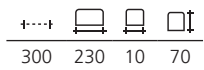

2Z104-L

2Z104-M

2Z104-R

44616

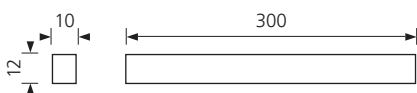
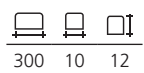

Anwendungsbeispiele

- Application Example
- Exemple d'utilisation
- Esempi di applicazione
- Ejemplo de utilización
- Przykłady zastosowań

2Z267

		
20	230	76

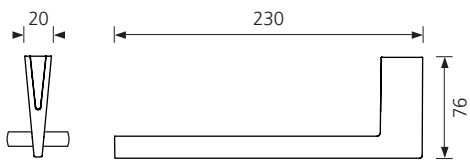

Mit optionaler LED-Beleuchtung

With LED lighting

Avec éclairage LED



Con illuminazione a LED

Con luz LED opcional

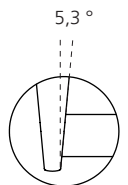
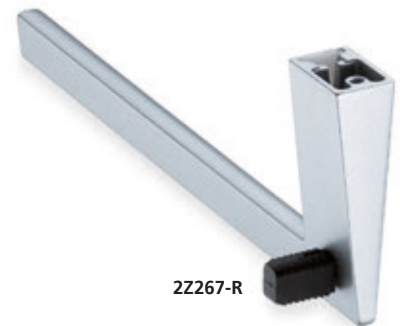
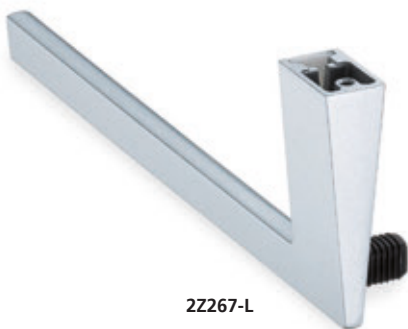
Z oświetleniem LED (opcjonalnie)



33633

		
300	14	16
500	14	16

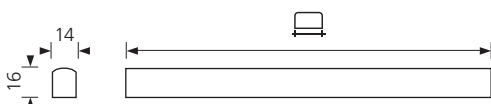



Anwendungsbeispiele

Application Example
Exemple d'utilisation
Esempi di applicazione
Ejemplo de utilización
Przykłady zastosowań



44649

Netzteil

Power supply
Bloc d'alimentation
Trasformatore
Transformador
Zasilacz

AC Input: 200 – 240 V ~ 50/60 Hz 0,4 A
DC Output: 12 V – 1,5 A, 18 W



44643

LED



22034

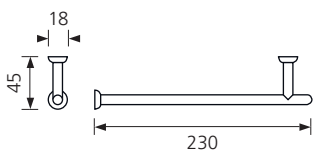

22039 + 22040

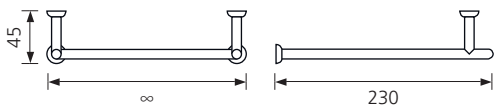
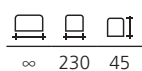

22039 + 22041

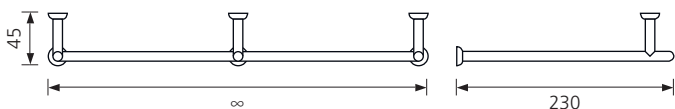

22316

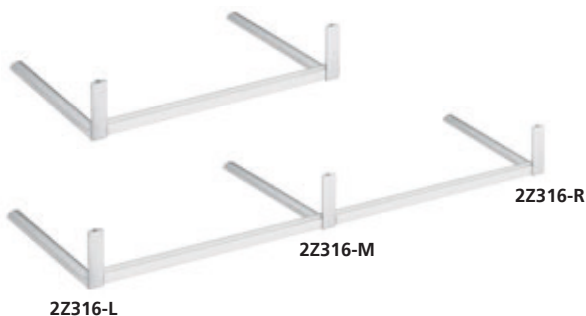
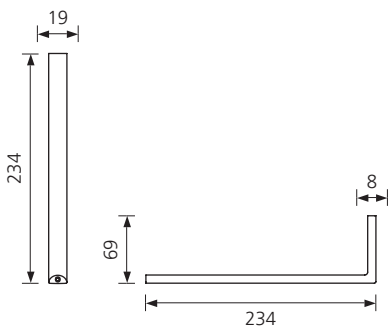
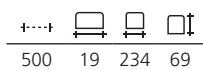

Anwendungsbeispiele
 Application Example
 Exemple d'utilisation
 Esempi di applicazione
 Ejemplo de utilización
 Przykłady zastosowań

22800

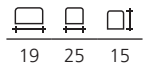

19 25 15

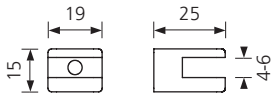

22918

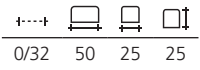

0/32 50 25 25

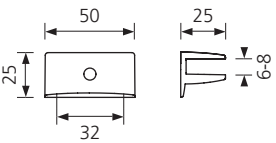

22573

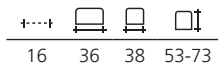

16 36 38 53-73

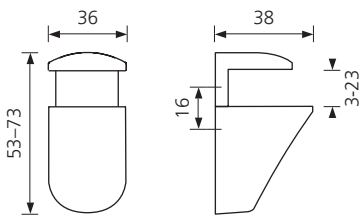

22947

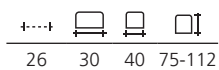

26 30 40 75-112

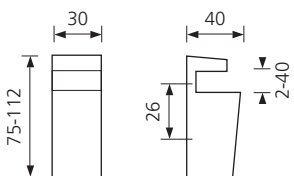

6K341



 32/32 110 110 19/34

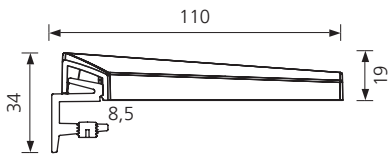

6K214

 Ø

 15 20

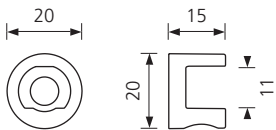

22943



 64 18 100 118-168

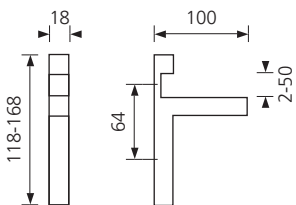

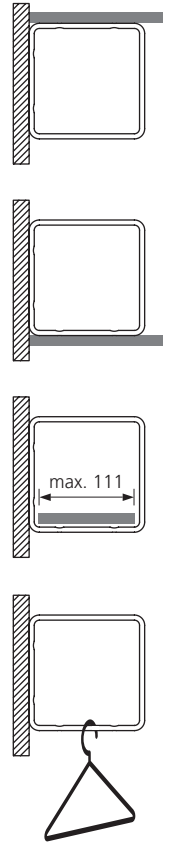
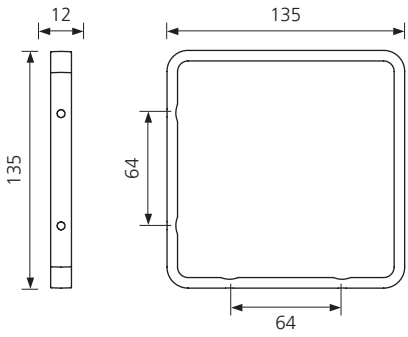
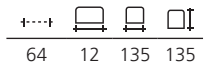

33940

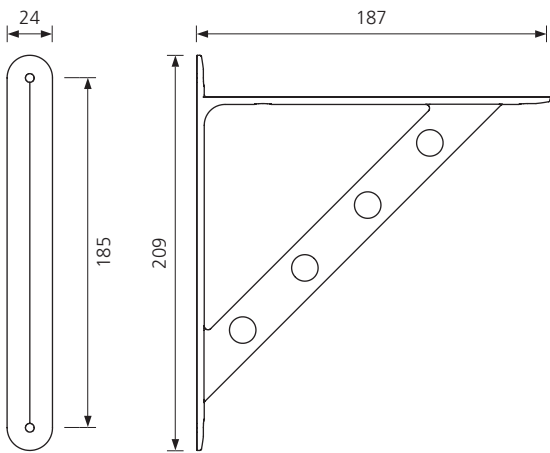
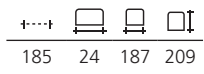

22247



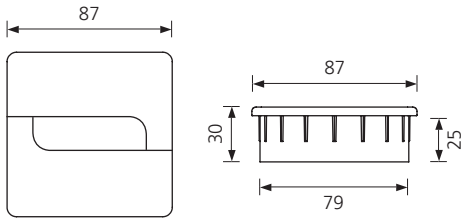

66796+66797

			\emptyset
87	87	30	79



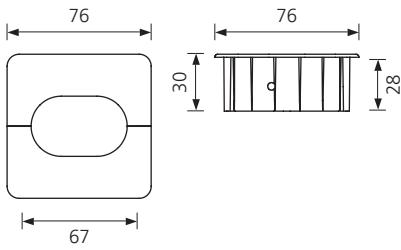

22195

			\emptyset
76	76	30	67



22194

			\emptyset
54	54	25	48

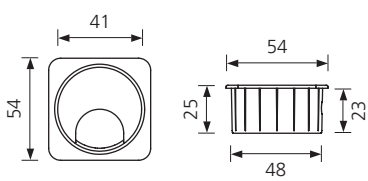

6K094 + 66797

\square \emptyset
29 79/88

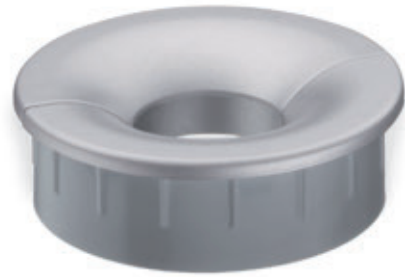
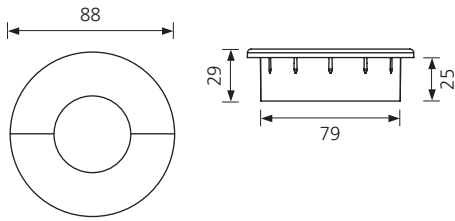

6K094

\square \emptyset
24 59/67

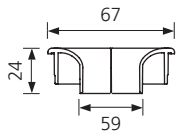

2Z335

\square \square \square
60 24 24
65 30 24

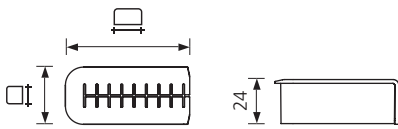



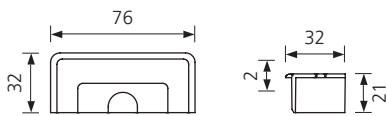

6K361

\square \square \square
76 32 21/2



Index

Indice / índice / Indeks

Art.		Art.		Art.		Art.	
22034	36	22967	33	66263	27	22195	40
22038	31	22969	33	66263+6K156	27	22198	14
22039+22040	36	22971	8	66265	24	22234	17
22039+22041	36	22978	26	66284	24	22236	16
22070	32	22980	7	66285	24	22247	39
22071	28	33154	11	66395	11	22267	34
22083	27	33171	22	66396	11	22276	27
22118	21	33173	22	66427	11	22313	16
22131	9	33174	22	66438	32	22316	36
22174	11	33175	22	66472	25	22317	15
22215	31	33176	22	66482	10	22327	17
22270	10	33177	13	66524	10	22333	7
22300	25	33178	13	66525	25	22335	41
22301	10	33633	34	66540	25	22337	16
22304	10	33707	20	66579	32	22354	15
22314	21	33796	31	66580	26	22360	15
22316	26	33797	31	66648	28	22434	14
22345	26	33901	13	66649	27	6K090	8
22348	26	33902	13	66671	18	6K094	41
22434	14	33903	13	66717	10	6K094+66797	41
22467	9	33905	12	66796+66797	40	6K104	6
22505	30	33906	12	66807	8	6K110	17
22571	30	33907	12	66865	18	6K155	8
22573	37	33940	39	66886	19	6K164	17
22681	30	34012	23	22044	7	6K184	20
22689	15	34013	23	22046	15	6K214	38
22703	29	44616	33	22048	14	6K276	33
22740	29	44643	35	22069	9	6K289	6
22749	29	44649	35	22084	9	6K304	7
22750	29	66024	21	22093	16	6K326	7
22784	30	66025	21	22104	33	6K341	38
22800	37	66062	11	22177	9	6K361	41
22918	37	66081	32	22184	6	6K397	6
22943	38	66261	28	22187	8		
22947	37	66261+6K156	28	22194	40		



Schwinn Beschläge GmbH
Röhrstraße 3
64372 Ober-Ramstadt

+49 61 54 63 45 0
info@schwinn-group.com
www.schwinn-group.com